

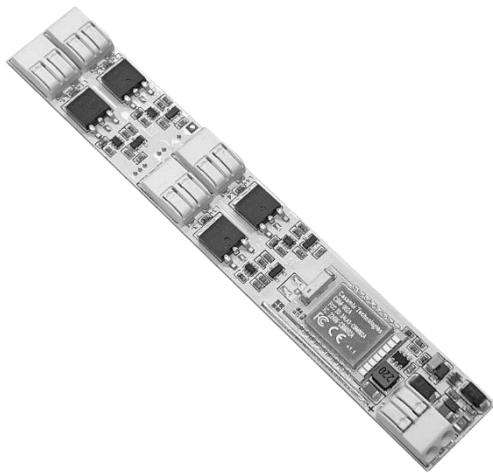

FEATURES

- DIMMER+CASAMBI
- DC input: 12-24 Vdc
- Command: APP Casambi
- N°4 Output channels
- Control: Dimmer White, Tunable White, RGB and RGBW
- Constant Voltage output for Common Anode applications
- Voltage Output for R loads
- Memory Function
- Adjusting the brightness of white light, monochromatic colour and CCT for Tunable White light
- Creating multiple colour scenes and selecting colour games
- Adjusting the brightness up to completed off
- Soft Start and Soft Stop
- Typical efficiency > 95% - 100% Functional Test

➤ CONSTANT VOLTAGE VARIANTS





CODE	SUPPLY VOLTAGE	CHANNEL	OUTPUT	COMMAND	
D118x18-1224-4CV-CBU	12-24 Vdc	4	4 x 4A (max 6A Tot)	APP CASAMBI	

D118x18-1224-4CV-CBU is delivered ex factory with RGB+W Fixture default setting.

➤ PROTECTIONS

OVP	Over Voltage Protection ¹	✓
RVP	Reverse Polarity Protection ¹	✓
IFP	Input Fuse Protection ¹	✓

➤ TYPE OF CASAMBI FIXTURE

FIXTURE	SUPPLY VOLTAGE	OUTPUT	CHANNEL	COMMAND	
CBU-D118X18 WWWW	12-24V dc	4 x CV	4	APP CASAMBI	
CBU-D118X18 TW	12-24V dc	2 x CV	2	APP CASAMBI	
CBU-D118X18 RGB	12-24V dc	3 x CV	3	APP CASAMBI	
CBU-D118X18 RGB+W	12-24V dc	4 x CV	3+1	APP CASAMBI	

¹ Only for control logic protection

➤ **REFERENCE STANDARD**

EN 61347-1	Lamp controlgear – Part1: General and safety requirements
EN 55015	Limits and methods of measurement of radio disturbance characteristics of electrical lighting and similar equipment
EN 61547	Equipment for general lighting purposes – EMC immunity requirements

➤ **TECHNICAL SPECIFICATIONS**

		Constant Voltage	
Supply voltage		Min: 10.8Vdc ... max: 26.4Vdc	
Input current		Max 6A	
Channel		4	
Output voltage		= Vin	
Output current		A/ch	A tot.
		4 A ²	6 A ²
Nominal power ²	@12V	48 W	72 W
	@24V	96 W	144 W
Power loss in standby mode		<500mW	
Type of load		R	
D-PWM dimming frequency		600 Hz	
D-PWM resolution		833 step	
Operating frequencies		2,400 ... 2,483 GHz	
Maximum output power		4 dBm	
D-PWM range		0 – 100%	
Storage temperature		min: -25°C ... max: +60°C	
Ambient temperature		min: -10°C ... max: +40°C	
Maximum Temperature at Tc		50°C ³	
Wiring	Solid sizes	0,2 ... 0,75 mm ² – 24 ... 18 AWG	
	Stranded sizes	0,2 ... 0,75 mm ² – 24 ... 18 AWG	
Wire preparation length		7 ÷ 10 mm	
Mechanical dimensions		118 x 18 x 10,5 mm	
Fixing		Bi-adhesive	
Weight		13 g	

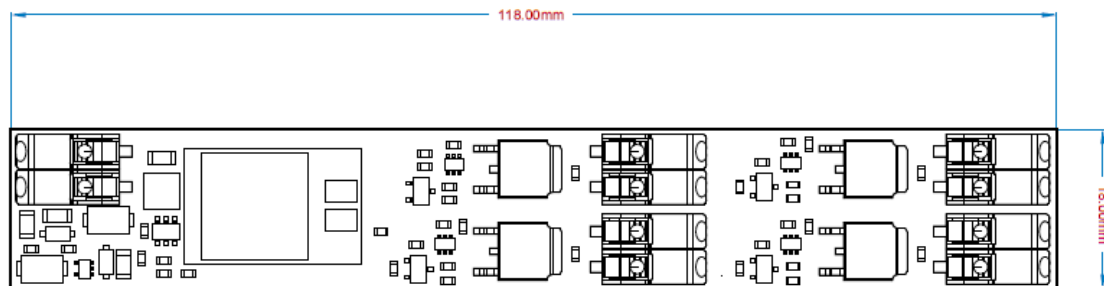
➤ **MECHANICAL DIMENSION**

² Maximum value, dependent on the dissipation conditions. This value is measured at 40°C, it is maximum Ambient Temperature.

³ Tc = 50 °C with Ta = 40 °C. At an ambient temperature of Ta = 20 °C → Tc = 30 °C

➤ **INSTALLATION**





To set the product, follow the instructions below:

- Fix the Casambi Driver inside the aluminium profile by the provided thermal Bi-adhesive;
- Connect the LED to the output channel;
- Connect the power supply into the input of the dimmer.

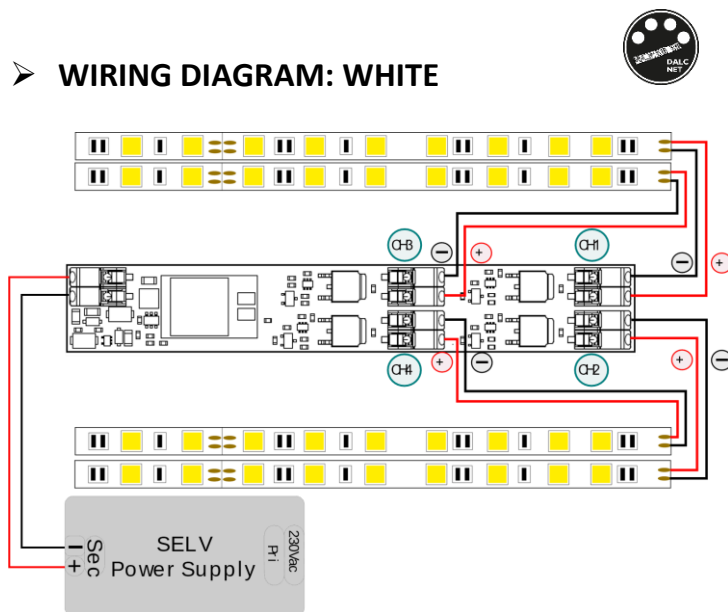
This Product as any other Casambi product, should not be placed in a metal enclosure or next to large metal structures. Metal will effectively block all radio signals which are crucial to operation of the product.

➤ **WIRING DIAGRAM: WHITE**





- Channel 1: Dimmer 
- Channel 2: Dimmer 
- Channel 3: Dimmer 
- Channel 4: Dimmer 

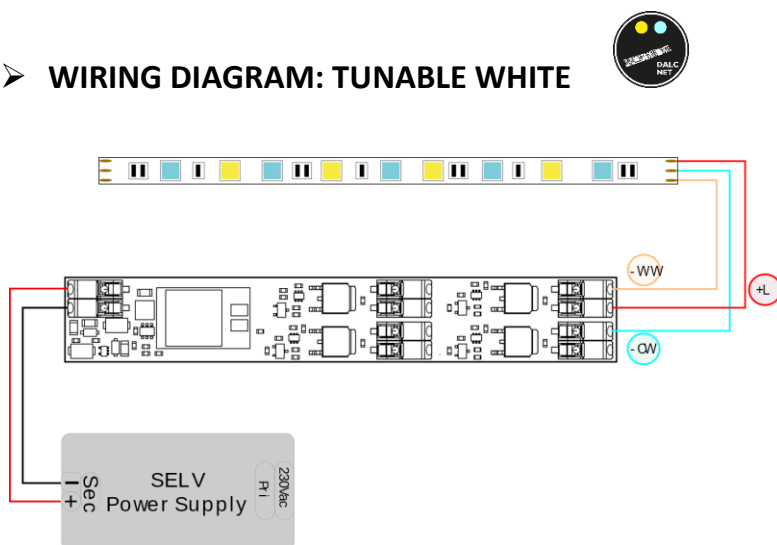

➤ **WIRING DIAGRAM: TUNABLE WHITE**



- Channel 1: Dimmer 
- Channel 2: Colour temperature 

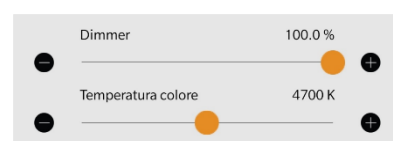

➤ **WIRING DIAGRAM: RGB**

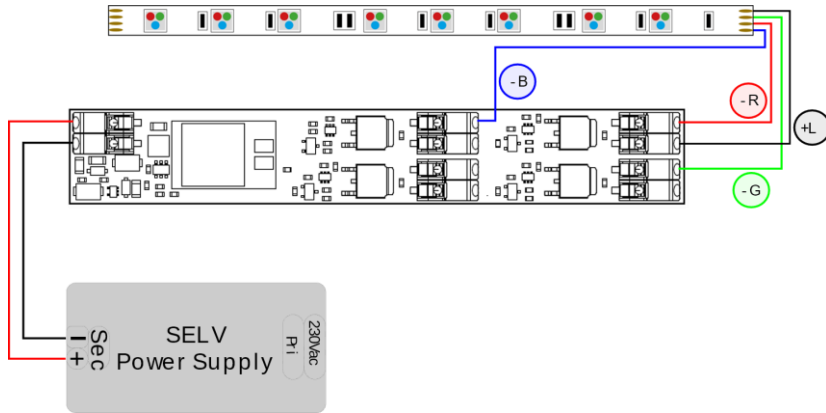

Channel 1: Dimmer

Channel 2: Colour

Channel 3: Colour Saturation

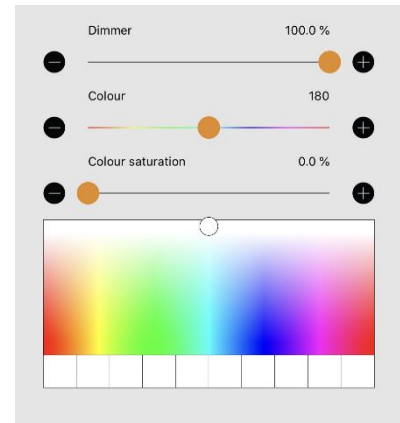

➤ **WIRING DIAGRAM: RGB+W**

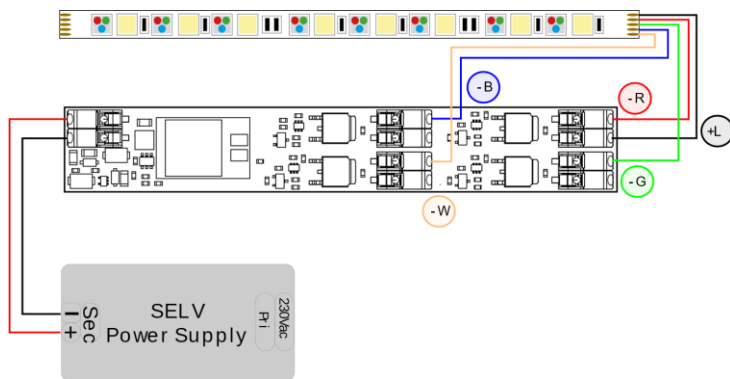

Channel 1: Dimmer

Channel 2: White / Colour

Channel 3: Colour

Channel 4: Colour Saturation

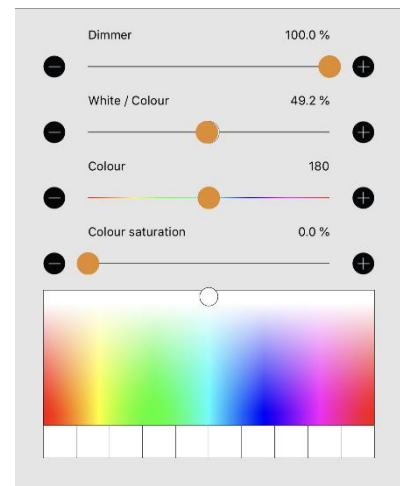

➤ Tc POINT

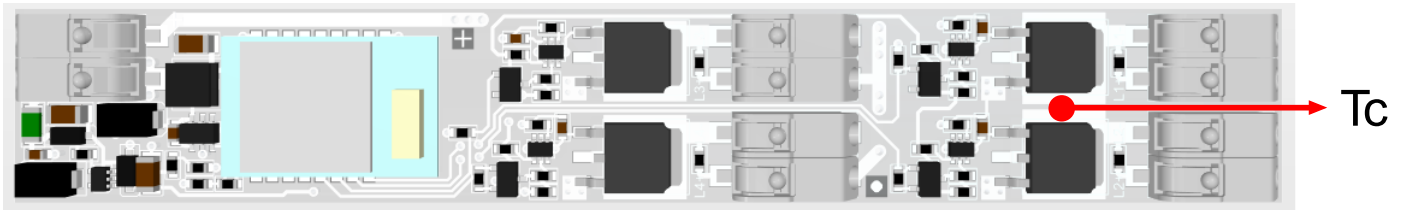

➤ TECHNICAL NOTE

Installation:

- Installation and maintenance must be performed only by qualified personnel in compliance with current regulations.
- The product must be dissipated correctly.
- Keep separated the circuits at 230V (LV) and the circuits not SELV from circuits to low voltage (SELV) and from any connection with this product. It is absolutely forbidden to connect, for any reason whatsoever, directly or indirectly, the 230V, the 230V mains voltage to the bus or to other parts of the circuits.

Power Supply:

- For the power supply use only SELV power supplies with limited current, short circuit protection and the power must be dimensioned correctly. In case of using power supply with ground terminals, all points of the earth (PE = Protection Earth) must be connected to a valid and certified protection earth.
- The connection cable between the power source "low voltage" and the product must be dimensioned correctly and they should be isolated from every wiring or parts at not SELV voltage. It is suggested to use double insulated shielded cables.
- Dimension the power supply for the load connected to the device. If the power supply is oversized compared with the maximum absorbed current, insert a protection against over-current between the power supplies and the device.

Outputs:

- The length of the connection cables between the product and the LED module must be less than 10m. The cables must be dimensioned correctly and they should be isolated from every wiring or parts at not SELV voltage. It is suggested to use double insulated shielded cables.

WARNING: For optional functionality of the Bluetooth signal, do not put the device into metal or aluminium boxes and do not shield the device.

As any other Bluetooth product, should not be placed in a metal enclosure or next to large metal structures. Metal will effectively block all radio signal which are crucial to the operation of the product.